

Layer: F.Mask

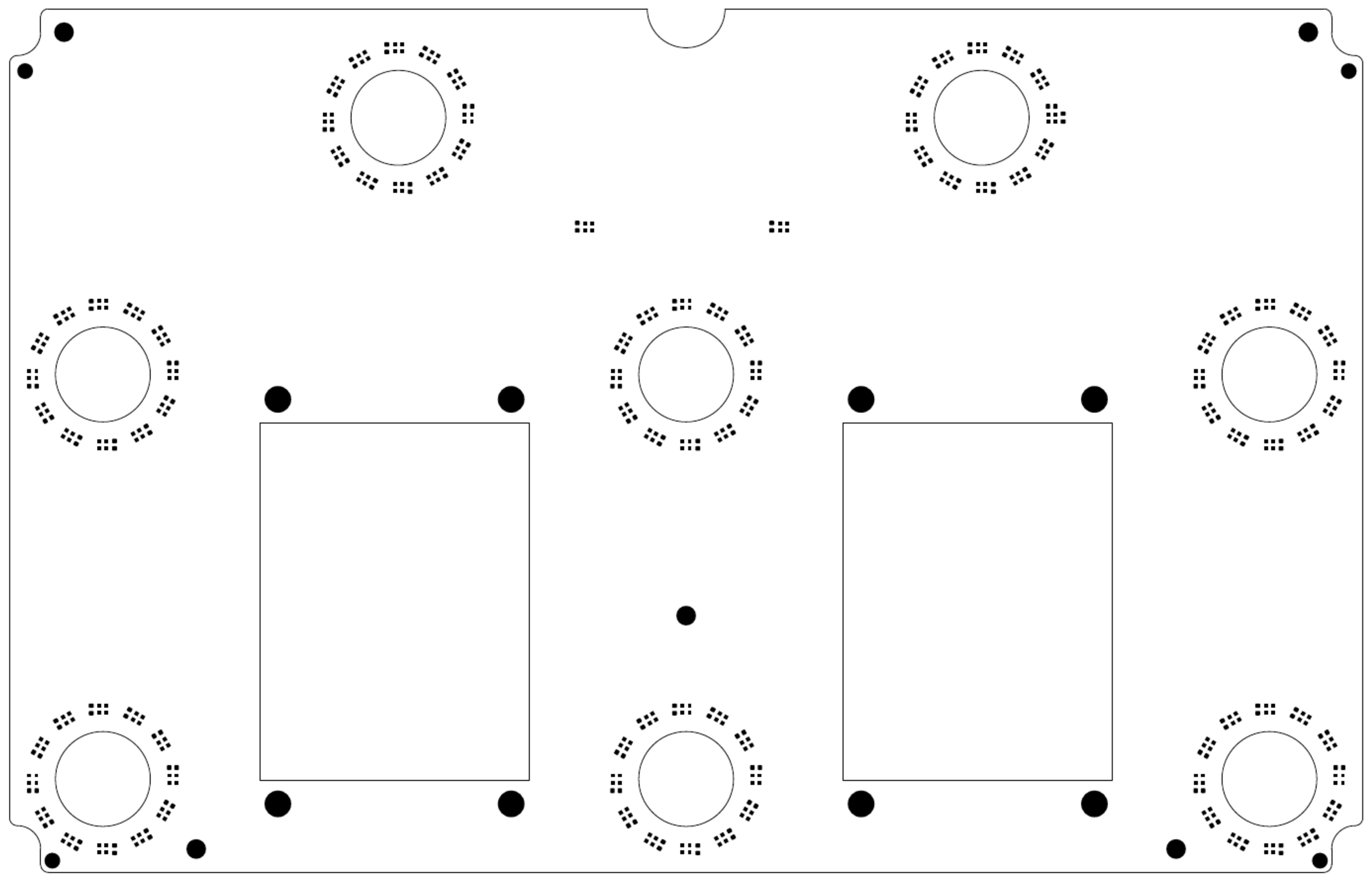

Layer: B.Cu

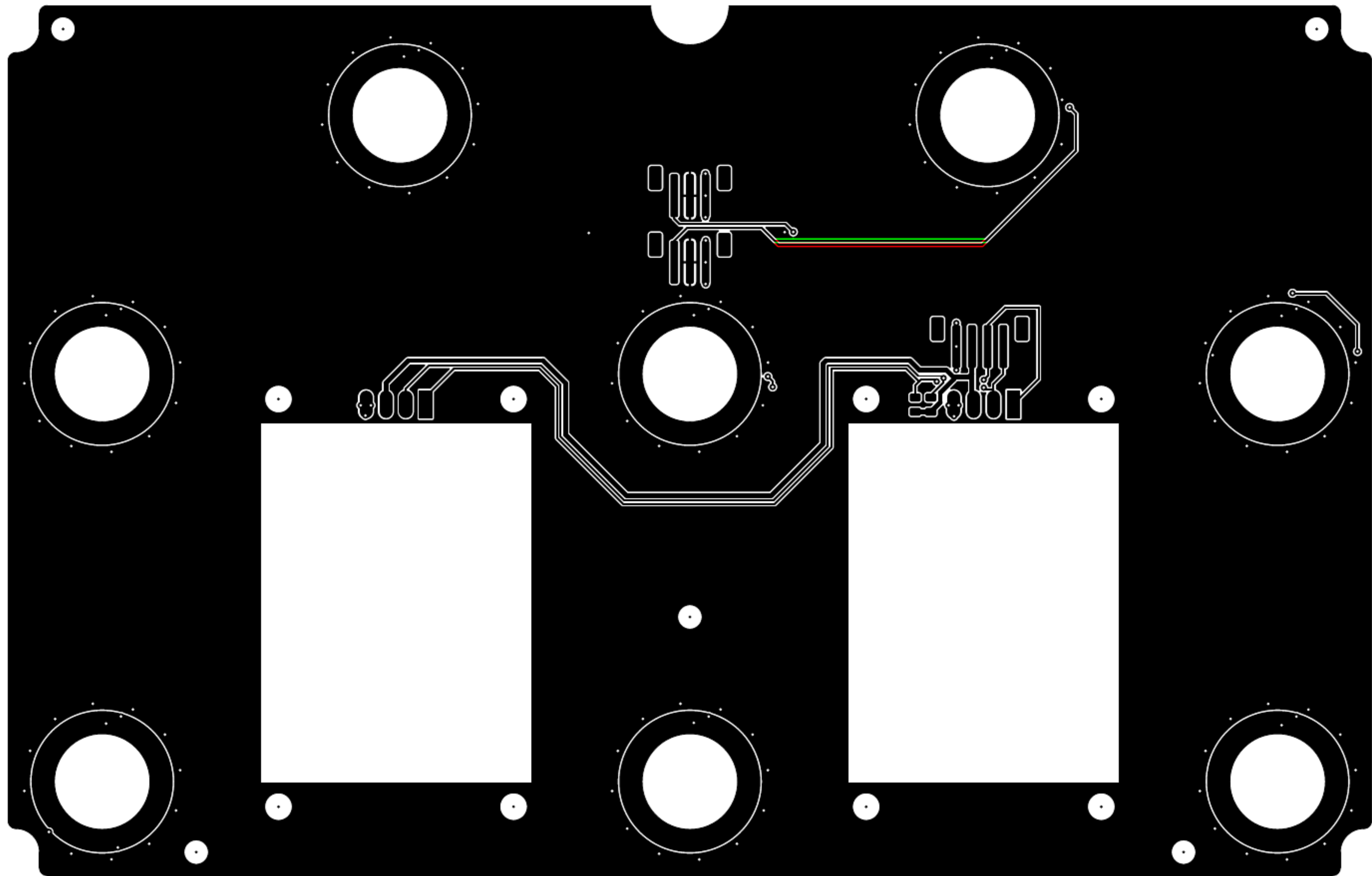

Layer: B.Mask

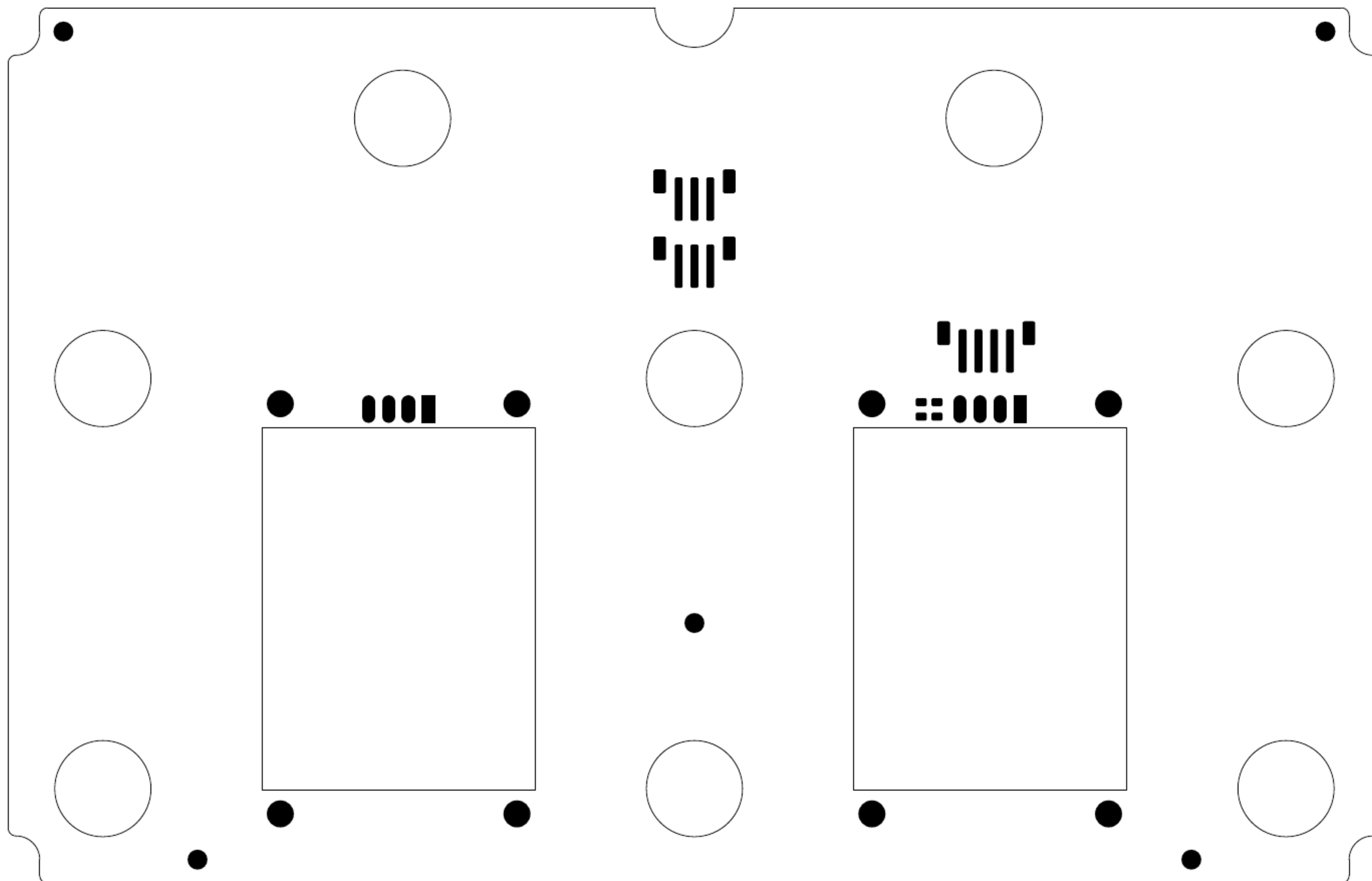

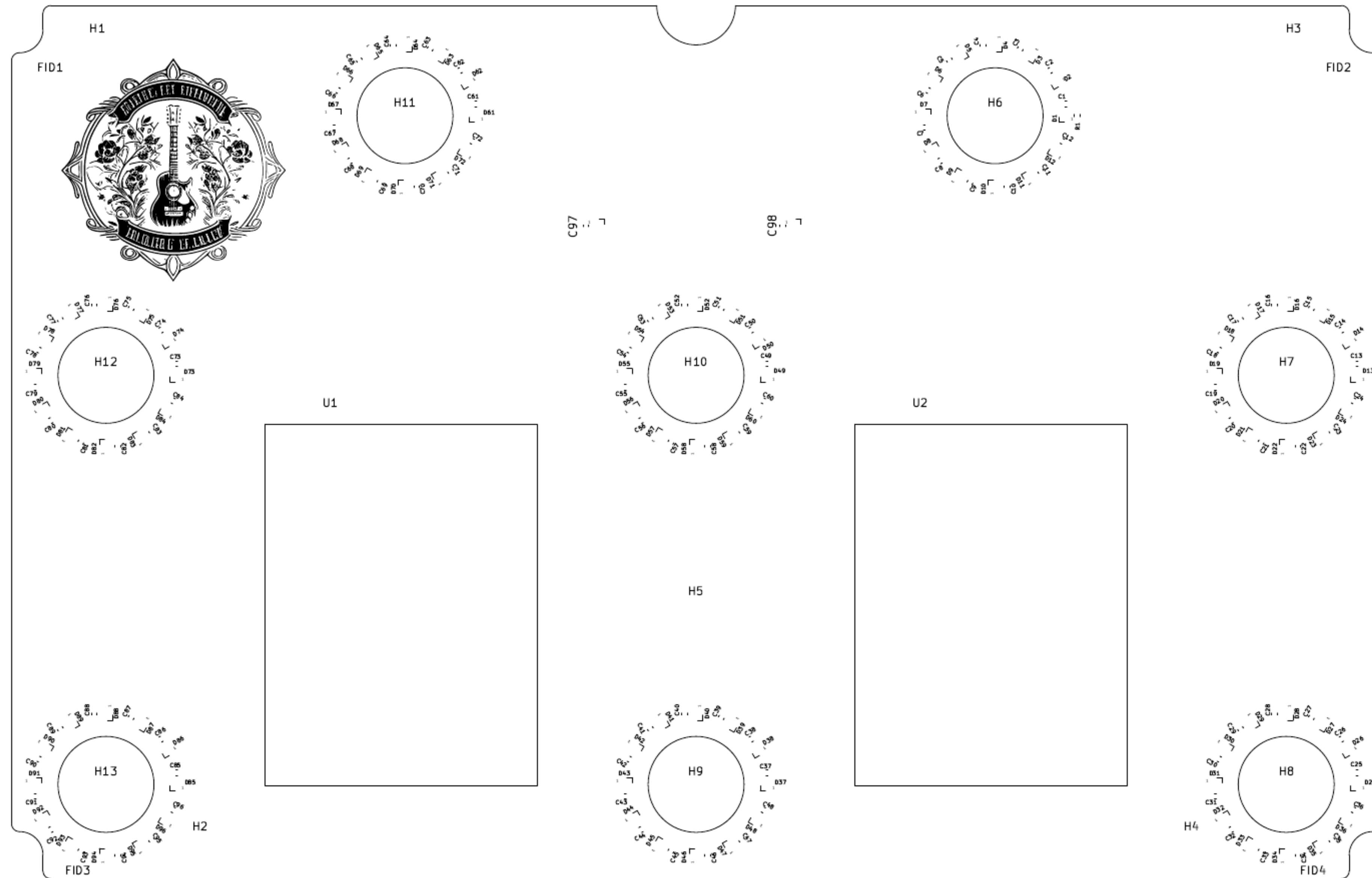

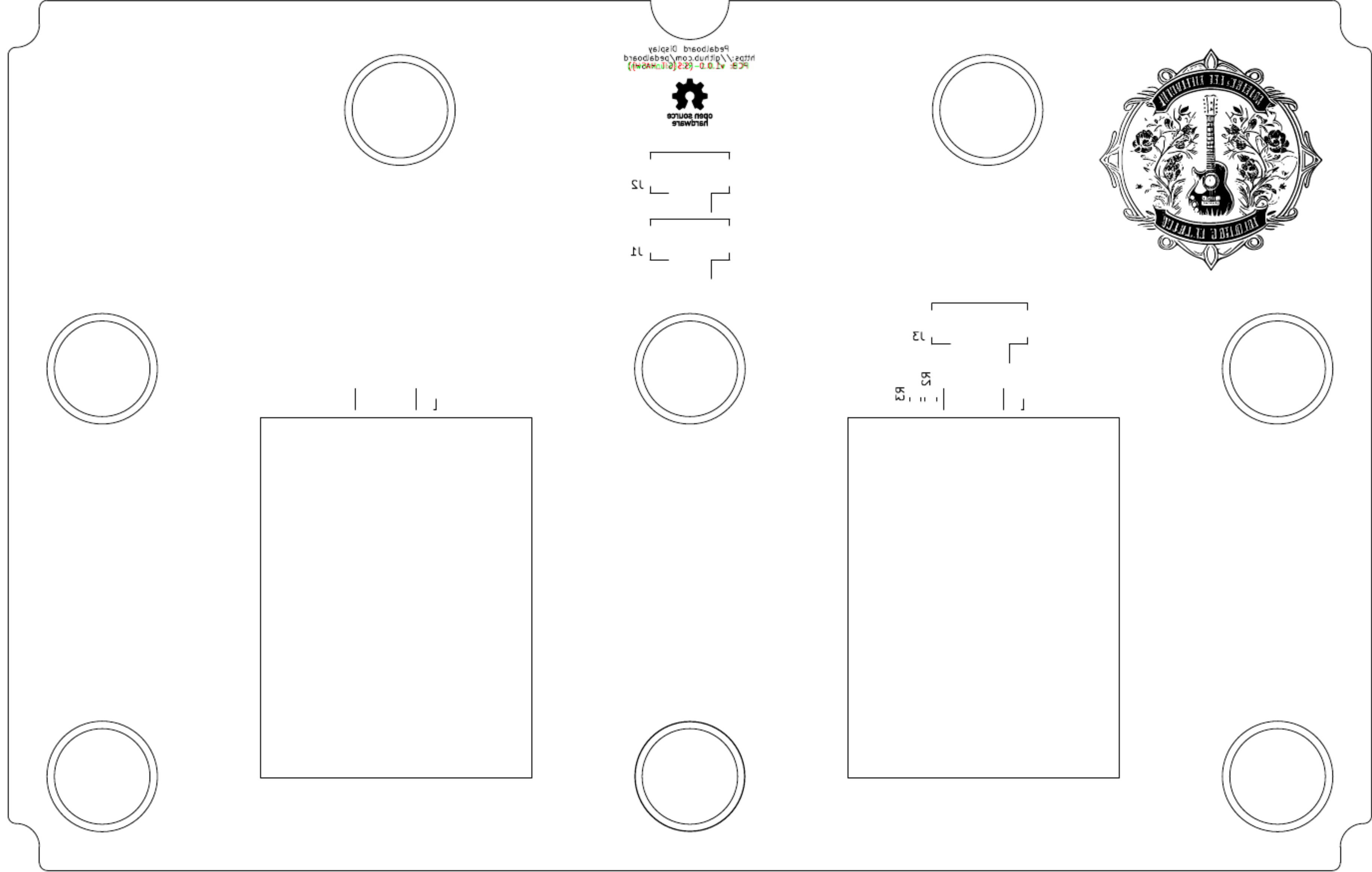

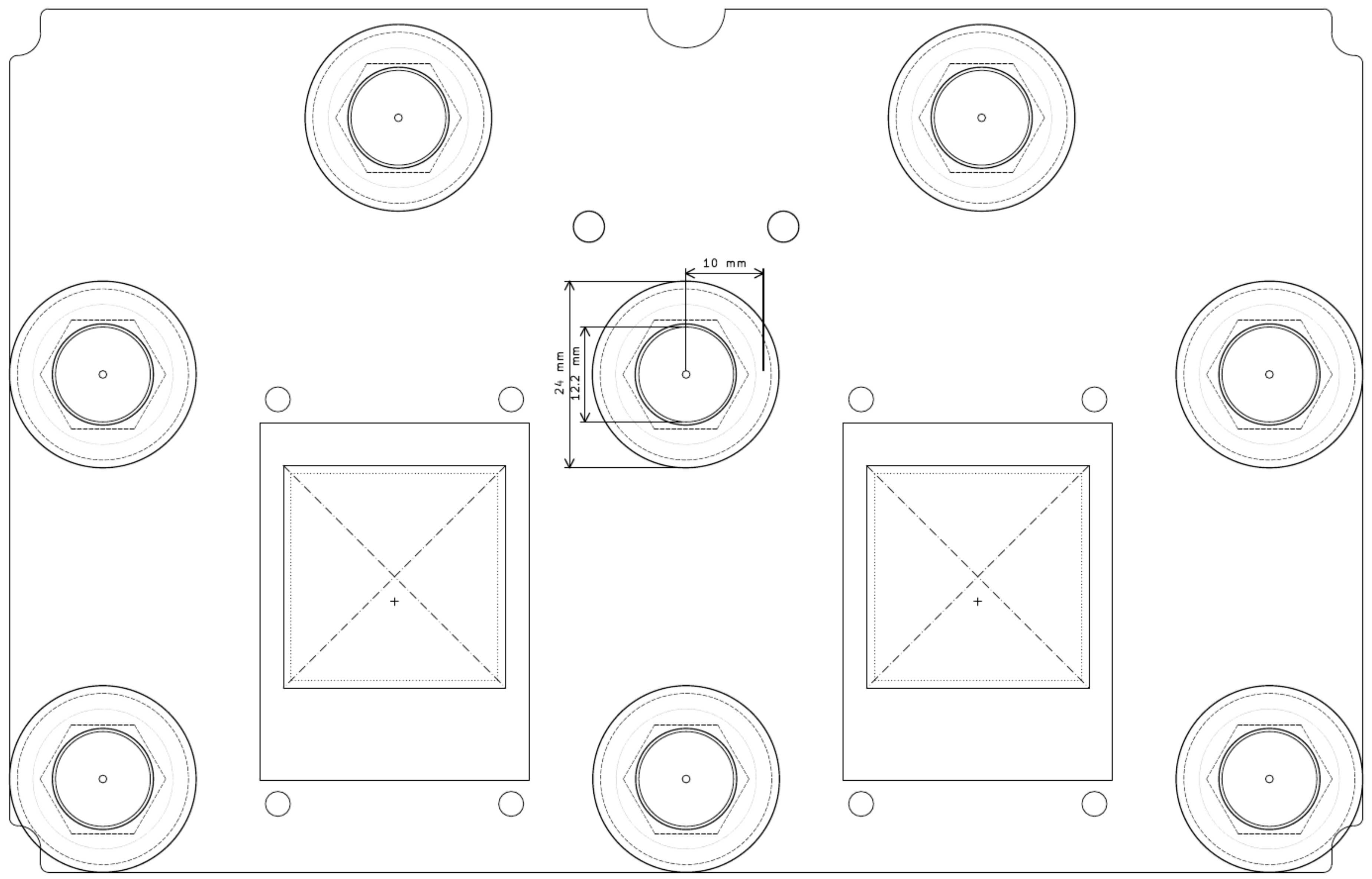

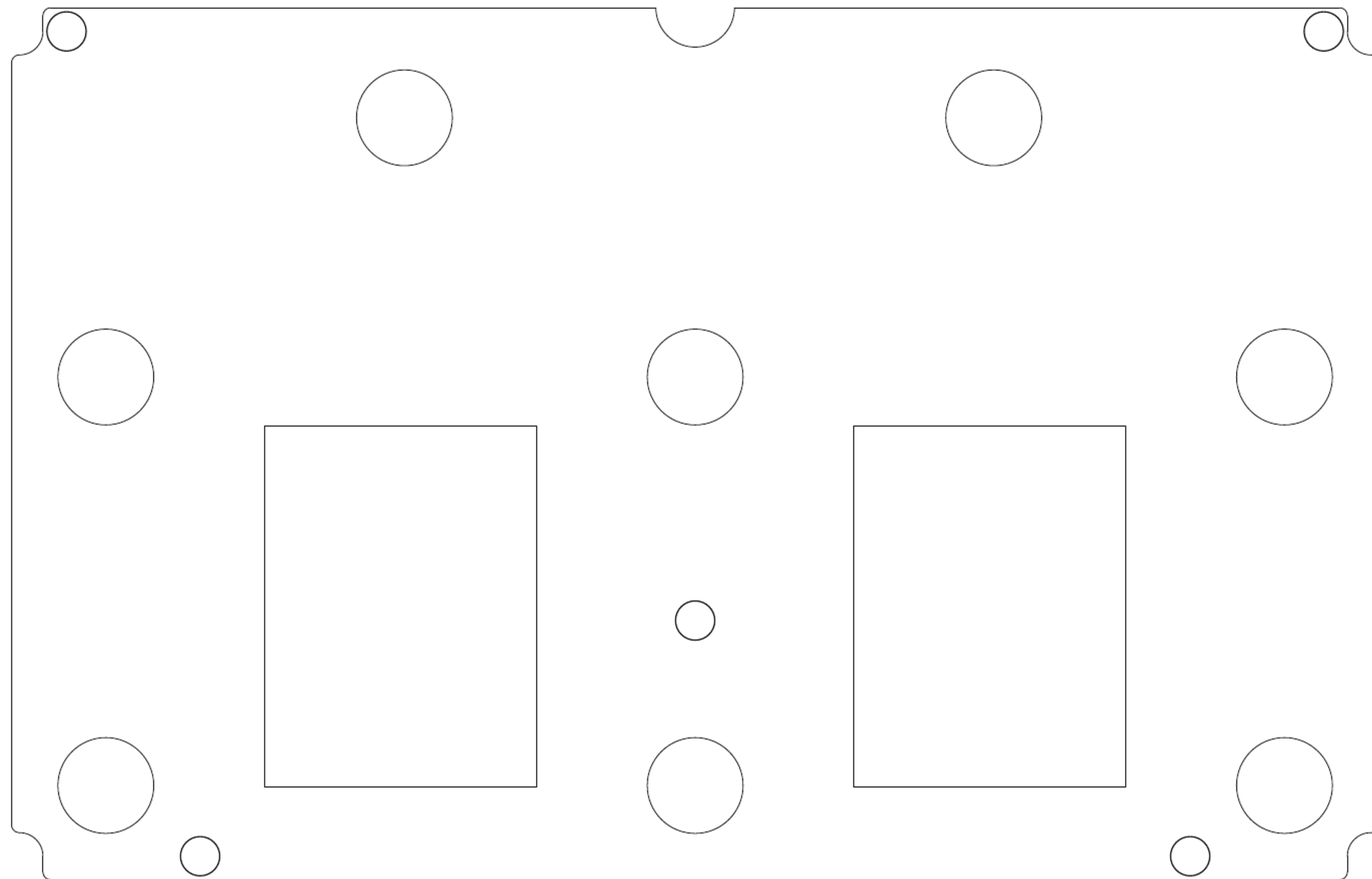

Layer: Edge.Cuts

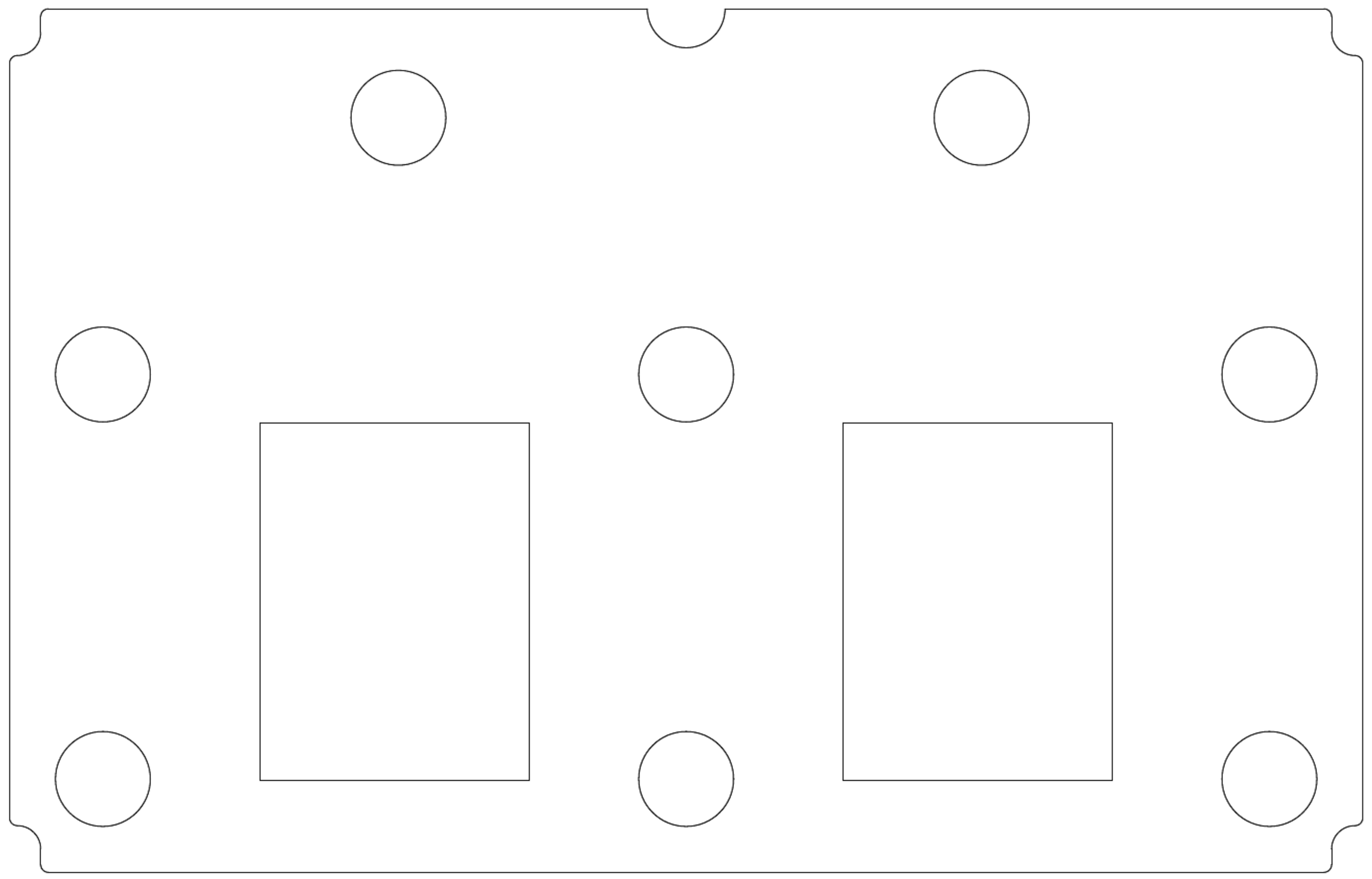

Layer: B.CrtYd (B.Courtyard)

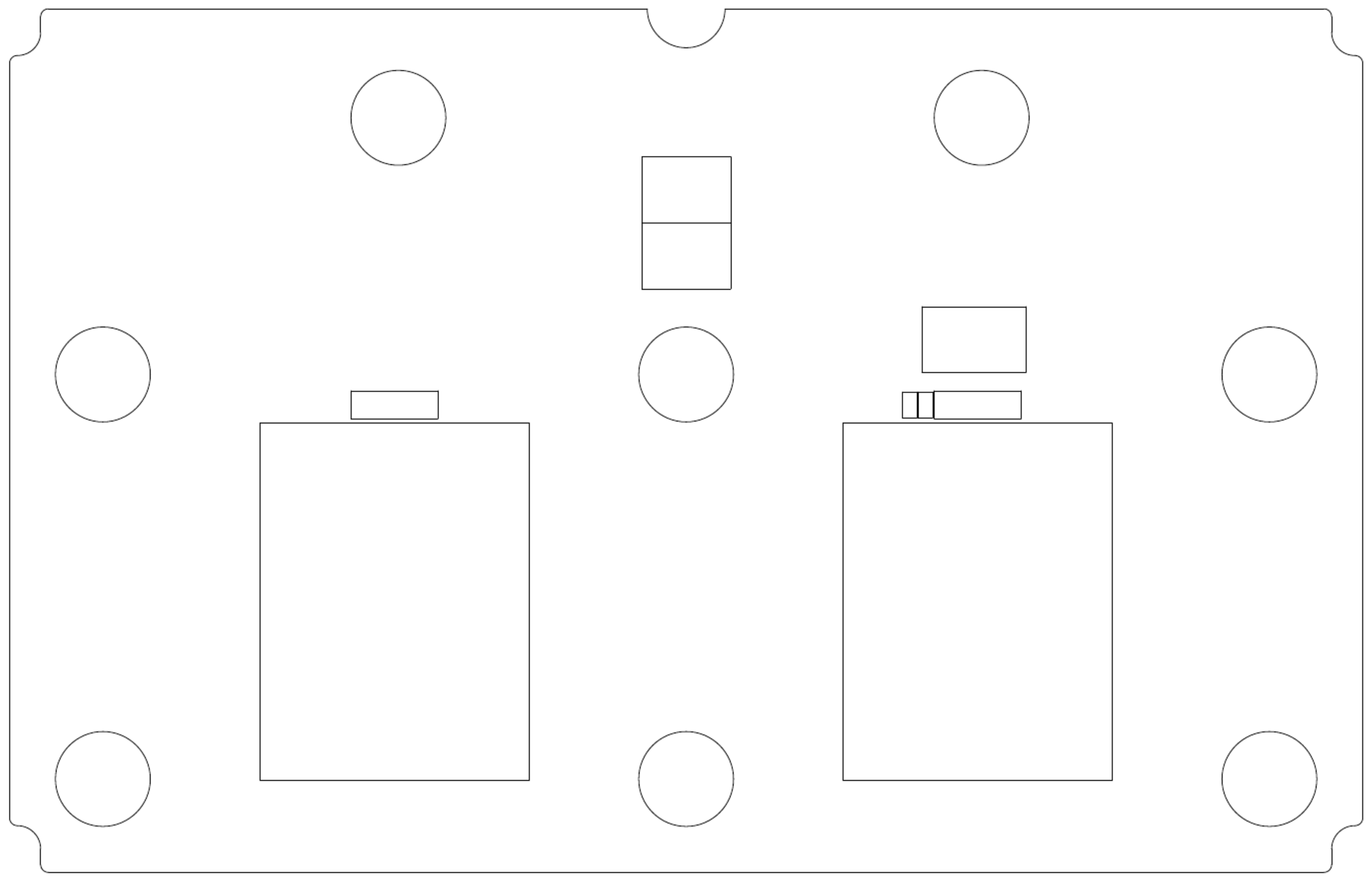

Layer: F.CrtYd (F.Courtyard)

